

## 4 Case studies

---

Three case studies were undertaken as part of the project. As mentioned in the main report, all three studies have started within the last year of the project, and data are still forthcoming to be analyzed in the follow-up project "Culture fisheries assessment methodology". The results presented here are thus of a preliminary nature.

The case studies cover three very different culture-based reservoir fisheries, each representing a particular type of fishery found in a region far larger than the study area.

Small reservoirs in Northeast Thailand (Esan) are managed as extensive or semi-intensive polyculture systems, with fertilization and occasionally feeding. The reservoirs are communally managed for multiple purposes, which may restrict the options for fish production. Similar reservoirs are found throughout Indochina, but fish production from these reservoirs is generally less intensive than in Thailand.

Medium size reservoirs in Zhejiang province, P.R. China, support well-developed culture-based fisheries, characterized by high stocking densities of relatively large seed fish, and high fishing effort. The fisheries are dominated by two planktivorous species, silver carp and bighead carp. Reservoir fisheries of this type operate throughout China, representing probably the most extensive culture-based fisheries in Asia.

Large irrigation reservoirs in Karnataka, India, are characterized by a very low fishing effort. Stocking is done at low densities, but nevertheless contributes significantly to the yield of the fishery. Reservoir fisheries of this type are common in South Asia.

**Tab. 2:** A comparison of culture-based fisheries at the case study sites: small communal reservoirs in NE Thailand, medium size reservoirs in Zhejiang Province, China, and large irrigation reservoirs in Karnataka, India.

	Small communal reservoirs NE Thailand	Medium size reservoirs Zhejiang, China	Irrigation reservoirs, Karnataka, India
Surface area (ha)	1 - 20	100-600	1,000-10,000
Depth (m)	1 - 4	10-20	10 - 40
Water regime	Perennial/seasonal	Perennial	Perennial
Pproduction (kg/ha/year)	200-600	100-900	10
Culture-based part of total yield	> 90 %	> 90 %	20-40 %
Management	Extensive to semi-intensive	Extensive	Extensive
Species stocked	Silver carp Bighead carp Common carp (Grass carp)  Rohu Mrigal Thai silver barb Tilapia	Silver carp Bighead carp (Common carp) (Grass carp)	Common carp  Catla Rohu Mrigal
Stocking density (numbers/ha)	3,000-25,000	200-1,400	100-400
Length of seed fish	2-3 cm	13 cm	5-7 cm
Fishing gear	Lift nets Cast nets	Seine nets Electrofishing	Gill nets Drag nets Cast nets Hook and line
Fishing effort	high	high	low
Average weight of produce (kg)	0.1 - 0.3	> 1	> 1
Use rights	Communal	State/cooperative	Common
Market	Local, provincial	Municipal	Local, provincial
Established	1985	1960	1980

#### 4.1 Communal small reservoirs in Northeast Thailand

Small water bodies are an important resource in Esan, the semi-arid northeastern region of Thailand. Consequently, many new water bodies have been created, and most natural water bodies have been subjected to extensive engineering works under various government programmes. Two such government programmes, the village fishpond programme and the green Esan programme, aim to establish fish culture in communal water bodies. A village fishpond committee is established, and its members attend a brief training course run by the Department of Fisheries (DOF). In the first year of operation, seed fish are supplied free of charge by DOF. The free supply is reduced to 50% in the second year, and 25% in the third year of operation. Village committees are expected to contribute the remaining 50% and 75% of the seed in the second and third year, and a full 100% in later years, using part of the revenue generated by the fishery.

Fieldwork in Udon Thani Province concentrated on two activities: a baseline survey of communal small reservoirs, and catch surveys of some of the small reservoirs which have been stocked by the DOF.

The baseline survey provides data on the physical status, the uses and the management of small water bodies. Information is obtained by means of structured interviews with pond committee members, by direct observation, and by limnological sampling. The baseline survey has initially concentrated on stocked small water bodies, for which preliminary results are given below. A complete survey of all communal water bodies in one district is currently being made, but results have not yet been analyzed.

Participatory rural appraisals of an intensively managed, and an essentially unmanaged communal small reservoir are currently being conducted, and some preliminary results are summarized below.

##### 4.1.1 Status and management of stocked small water bodies

The baseline survey of small water bodies in Udon Thani province has initially focused on stocked reservoirs. Out of a total of 18 water bodies surveyed before June 1994, 15 had been stocked in 1993. An overview of the status and management of these reservoirs is given in the following paragraphs.

The surveyed water bodies vary in area from 1.4 to 15.4 ha (median 5.1 ha), and are managed communally by villages of between 48 and 550 households. Most ponds have been built or improved by either the Fisheries or the Irrigation Department, and consist of a deep (3 m) and a shallow (1.5 m) part. The shallow part may dry up during the hot season, while a water level of at least 1.5 m is maintained in the deep part, thus making the pond a perennial water body.

The majority (67%) of stocked small water bodies are managed extensively, with 27% being stocked only, and 40% stocked and fertilized with animal manure. The remaining 33% of ponds are under more intensive management with stocking, fertilization and feeding. Local materials are used feed. The intensity of fertilization and feeding varies between reservoirs. The fact that fertilization or feeding occurs does not necessarily mean that it has a tangible effect on production. Hence the management of small reservoirs for fish production is generally extensive.

Stocked species comprise common carp (*Cyprinus carpio*), Chinese carp (silver carp *Hypophthalmichthys molitrix*, bighead carp *Aristichthys nobilis*, and grass carp *Ctenopharyngodon idella*), Indian major carp (mrigal *Cirrhinus mrigala* and rohu *Labeo rohita*), Thai silver barb (*Puntius gonionotus*), and Nile tilapia (*Oreochromis niloticus*). Of these species, only silver barb is indigenous to Thailand. The predatory snakehead *Channa striata* and walking catfish *Clarias batrachus* occur naturally in the ponds, together with some minor species.

Seed fish are stocked at a length of 2-3 cm. Some villages have in the past experimented with nursing in hapas or small ponds, but all such attempts have been abandoned due to lack of inputs or lack of perceived benefit.

Apart from fish culture, the stocked water bodies are used for buffalo wallowing (87%), irrigation of vegetable plots (67%), water for domestic use (33%), and the collection of snails (27%) and water plants (20%). Multiple uses and use conflicts are discussed in more detail below.

Of the stocked ponds, 47% receive the seed fish exclusively from the Department of Fisheries, 20% exclusively from private hatcheries, and 33% from both DOF and private hatcheries.

Ponds are stocked once a year between May and August, and harvested a year later on a single day between March and June. In all stocked ponds in the survey, harvesting is restricted to a single fishing day per year. Fishing licences ("tickets") for the day can be purchased by anybody, and fishing days tend to attract many people from outside the village. Part of the proceeds from the fishing day are used to purchase new seed fish, but the largest share is used for communal projects like temple, school or road improvement. For the surveyed water bodies, the ticket revenue ranged from 250 to 13,800 B (median 5500 B) per hectare, as compared to an income of about 16,000 B per hectare from a well-managed farmer pond (1 Baht equals £ 0.025).

#### **4.1.2 Management of non-stocked small water bodies**

Only three small water bodies included in the baseline survey have not been stocked recently. One of these ponds is very deep (5 m), and is used exclusively for domestic water supply, with no other uses being permitted. Open access fisheries operate on the other two ponds, which have established breeding populations of tilapia and some residual populations of other species from earlier stocking. In addition, wild fish (particularly snakehead) and shrimps contribute to the catch. No estimate of total yield is available at present.

A participatory appraisal (PRA) of one of the non-stocked ponds has shown that the fishery operates all year round at a low intensity. Fishing is done primarily by farmers with small to medium size holdings, during periods when the demand for labour on the farm is low. Landless households and those with very small holdings tend to migrate away from the village during periods of low demand for farm labour, and consequently do not engage in fishing. The most important non-fish food items collected from the pond are water plants and snails. Such natural food can be quite important in the diet of villagers, particularly during the hot season when local agricultural produce is relatively scarce. Hence a small water body can make an important contribution to seasonal food security, provided that these food items are available in the pond, and that their collection is permitted.

#### **4.1.3 Multiple uses and use conflicts**

Information on multiple uses and use conflicts and exclusions in small water bodies were obtained in the baseline survey. Because this information relies largely on interviews with a single person in each village (usually the headman), the emerging picture is potentially biased. Accepting this limitation, it is nevertheless possible to derive some working hypotheses which can then be subjected to scrutiny in more in-depth and participatory studies.

A tentative table of use conflicts and exclusions is provided in Tab. 3, which shows the effect of each use on all other uses. The table is based on use exclusions observed during the baseline survey, and on external information on causal relationships. For example, it was observed that buffalo wallowing is not usually allowed in ponds which are important for domestic water supply. This use exclusion results from the negative effect of buffalo wallowing on water quality, in combination with the high priority assigned to water quality for a particular pond. In the table, this conflict is shown as a negative influence of buffalo wallowing on domestic water supply, but not vice versa as the domestic use of water does not directly affect buffalo wallowing.

The supply of water for animals, domestic use, and irrigation of vegetable plots does not directly affect other uses, as long as the abstracted volume of water is relatively small.

**Tab 3. Use interactions in small reservoirs, Northeast Thailand.**

Use	affects use									
	Drinking water for animals	Domestic water supply	Irrigation of vegetables	Fish stocking	Fertilization	Catching wild fish	Catching shrimps	Collecting snails	Collecting vegetables	Buffalo wallowing
Drinking water for animals	x									
Domestic water supply		x								
Irrigation of vegetables			x							
Fish stocking				x		-	-	-	-	
Fertilization	-	-		+	x					
Catching wild fish				-		x				
Catching shrimps				-			x	y		
Collecting snails								x		
Collecting vegetables									x	
Buffalo wallowing	-	-		?					-	x

Fish stocking results in restrictions to a number of other uses, due to physical changes in the pond environment, and access restrictions introduced to protect the stocked fish. The use of any fishing gear outside the fishing day was prohibited in all stocked ponds, hence no wild fish or shrimp could be harvested. It is unclear at present to what extent the stocking of fish affects the quality of the habitat for wild fish and invertebrates. Observation suggests that natural small water bodies in the region have macrophyte-detritus dominated foodwebs, while intensive stocking (including herbivorous fish) commonly results in a plankton-dominated food web. Interviews with experienced local fishermen also indicate that the best places to catch wild fish are those with some degree of macrophyte cover. The degree of macrophyte cover also affects the use of the pond for collecting snails and, most directly, for collecting vegetables. To summarize, the stocking of fish tends to restrict the availability of natural foods from the pond for both technical and administrative reasons.

Pond fertilization is generally beneficial with regards to fish stocking. However, intensive fertilization may also cause a deterioration of water quality, and in extreme cases render water unsuitable as drinking water for animals and for domestic use. Hyper-eutrophic conditions with thick films of blue-green algae have been observed in three ponds, two of which received regular inputs of wastewater from pig farms. The occurrence of hyper-eutrophic conditions indicates that the supplied nutrients are insufficiently utilized by the fish population, i.e. the problem may lie in inadequate stocking as well as in over-fertilization.

The catching of wild fish and shrimps may affect the stocked fish populations if unselective gear is being used, and consequently the use of any fishing gear is prohibited in stocked ponds outside the fishing day. However, many traditional gear types like snakehead traps, baited hooks, or small push nets for shrimp fishing are highly selective. Hence technically, the use of such gear could be allowed throughout most of the year without affecting the stocked fish. This would, however, require a more complex set of access rules.

Buffalo wallowing can have a strong effect on water quality, as well as on macrophyte cover. The physical effects of wallowing are the resuspension of sediment, the release of excreta into the water, and the feeding on macrophytes. All three effects are negative with regards to water use for animals and domestic purposes. The effect of buffalo wallowing on fish production is unclear, as it depends on the relative magnitude of the increases in nutrient availability on the one hand, and of turbidity on the other hand.

Whether or not the above mentioned use interactions actually lead to restrictions, and to conflicts among users depends on two factors: the relative importance of conflicting uses, and the availability of alternative water bodies for displaced uses. A restriction on the harvesting of wild fish and shrimps from a stocked pond, for example, may not cause any problem if other ponds or canals nearby are available for this purpose. Indeed, many villages were found in the baseline survey to have access to several communal water bodies, each managed for a different set of non-conflicting uses.

#### **4.1.4 Yield from stocked small water bodies**

The results of three catch surveys conducted in small reservoirs in February and March 1994 are summarized in Tab. 4.

In Hong Lak Tuk, total yield was estimated as 345 kg/ha. The average yield per ticket sold was 4 kg. Assuming a price of 20 B/kg, the average value of the catch per ticket sold was 80 B. The ticket price was 50 B, so that the average fisherman has made a gross profit of 30 B. No separate estimates are available for the deep and shallow parts of the reservoir. The value of the catch was 6900 B/ha and the cost of seed 970 B/ha, which gives a theoretical gross profit from the culture fishery of 5930 B/ha.

In Poo Sri Sumran, total yield was estimated as 450 kg/ha, and the average yield per ticket sold was 5 kg, equivalent to 100 B. However, the yield per ticket varied greatly between the deep and the shallow areas of the pond. In the deep area, yield was 10 kg per fisherman (dominated by silver carp and rohu) while the shallow area yielded only 3 kg per fisherman. At an average fish price of 20 B/kg, and the ticket price of 100 B, deep area fishermen have made an average gross profit of 100 B, while shallow area fishermen have on average lost 40 B. The value of the catch was 9020 B/ha and the cost of seed 3250 B/ha, which gives a theoretical gross profit from the culture fishery of 5770 B/ha.

**Tab. 4.** Summary of the catch survey results

	Hong Lak Tuk	Poosri Sumran	Nong Na Lam
Fishing day	26/2/94	13/3/94	6/3/94
Stocking month	8/93	5/93	5/93
Area (ha)	5.1	15.4	8.0
Stocking density (no./ha)	7550	24700	3750
Yield (kg/ha)	345	450	< 10
Tickets sold	468	1450	
Yield per ticket (kg) average deep area shallow area	4	5 10 3	0
Value of catch per ticket (B) <sup>1</sup> average deep area shallow area	80	100 200 60	0
Price of ticket (B)	50	100	20
Gross profit per ticket (B) average deep area shallow area	30	0 100 -40	-20
Value of catch (B/ha) <sup>1</sup>	6900	9020	0
Cost of seed (B/ha) <sup>2</sup>	970	3250	375
Theoretical gross profit (B/ha)	5930	5770	-375

Notes

<sup>1</sup>A price of 20 B/kg is assumed.

<sup>2</sup>The seed prices assumed are 0.2 B per fish for silver carp, bighead carp, and rohu; and 0.1 B per fish for all other species.





**Figure 12. Fishing day in a communal small reservoir, Northeast Thailand.** Top: Shallow area of the reservoir. Ticket holders are wading in the pond, fishing individually with cast nets (men) and lift nets (mostly women). Bottom: Deep area of the reservoir. Note the teams of fishermen fishing from the floats.



In the third reservoir, Nong Na Lam, catches were virtually nil despite stocking in the previous year. This indicates the occurrence of exceptionally high mortalities, possibly related to stress due to the transportation and handling of seed fish.

The species yield for Hong Lak Tuk and Poo Sri Sumran is shown in Fig. 12. In both reservoirs, yield is dominated by Chinese carp (silver and bighead), which account for more than 50% of total yield. As indicated in the summary, the catch per fisherman can vary considerably according to the location in the reservoir where she or he is operating, and according to the gear used. Most small reservoirs comprise a shallow (1.5 m), and a deep (3 m) area. In the shallow area, fishermen wade into the pond and use both lift net and cast net (Fig. 12 A). In the deep area, fishermen use mainly cast nets from floats or tripods (Fig. 12 B). Fishing in the deep area is often dominated by semi-professional teams of fishermen who may travel long distances to attend fishing days in productive reservoirs. Fishing in the shallow parts of the pond tends to be dominated by local people. Cast nets are used exclusively by men, while lift nets are used predominantly by women. A very detailed catch survey has been conducted in Poo Sri Sumran in order to assess the differences in yield between gear types and areas.

In Fig. 13, catch per fisherman of each species in Poo Sri Sumran is shown separately for the shallow and the deep area, and for lift nets and cast nets. The catches of most species are similar in both areas, with the important exceptions of mrigal and silver carp. Catches of both species are much higher in the deep area, which explains the overall higher catches taken in that area (Tab. 4). In both areas and for most species, a lift net fisherwoman catches about twice as much as a cast net fisherman. A strong exception are silver carp in the deep area, which are caught mainly by cast nets.

The differences in catch between gear types and pond areas have important consequences for the distribution of benefits from the fishery. Semi-professional cast net fishermen operating in the deep area caught 14 kg and made a profit of 180 B per person, within four or five hours including travel. This result, compared to average daily wages of 40 B for agricultural or construction work in the region, or 100 B for construction work in Bangkok, easily explains the attractiveness of fishing day visits for these fishermen. This implies that a significant proportion of the benefits from the fishery accrue to persons from outside the local community which bears the costs of management. Lift net fishermen, mostly local women, caught about 5 kg and thereby just recovered the cost of the ticket. The costs are born largely by local men, who use cast nets to fish in the shallow area. The men catch less than 2 kg, and make a loss of more than 60 B per person. This problem has not escaped the attention of some men, who prefer to use lift nets instead of cast nets, the conventional "male" gear.

Length distributions of all stocked species in the catch from Hong Lak Tuk are shown in Fig. 14. Tilapia form a stunted population, with few individuals reaching a length over 15 cm. The populations of puntius, mrigal and rohu consist of more than one age group, with the older individuals dominating the population in terms of biomass. The silver carp population is dominated by the cohort stocked in 1993, which has shown a high growth rate. Bighead carp have not been stocked in 1993, and the population consists exclusively of old and large individuals.

Length distributions for Poo Sri Sumran are shown in Fig. 15. Tilapia form a stunted population, possibly comprising two size groups with mean lengths of 13 and 21 cm, respectively. Puntius are mostly small, with few individuals attaining lengths above 20 cm. The catches of common carp, rohu and silver carp consist partly or entirely of older cohorts.

The length distributions provide important information for management. The occurrence of dense, stunted tilapia populations indicates that the species has established breeding populations, and that predation pressure in the ponds is relatively low. The presence of large and old individuals of many species shows that the ponds provide a good habitat for fish all year round, and that a significant proportion of the population escapes the annual fishing operation.

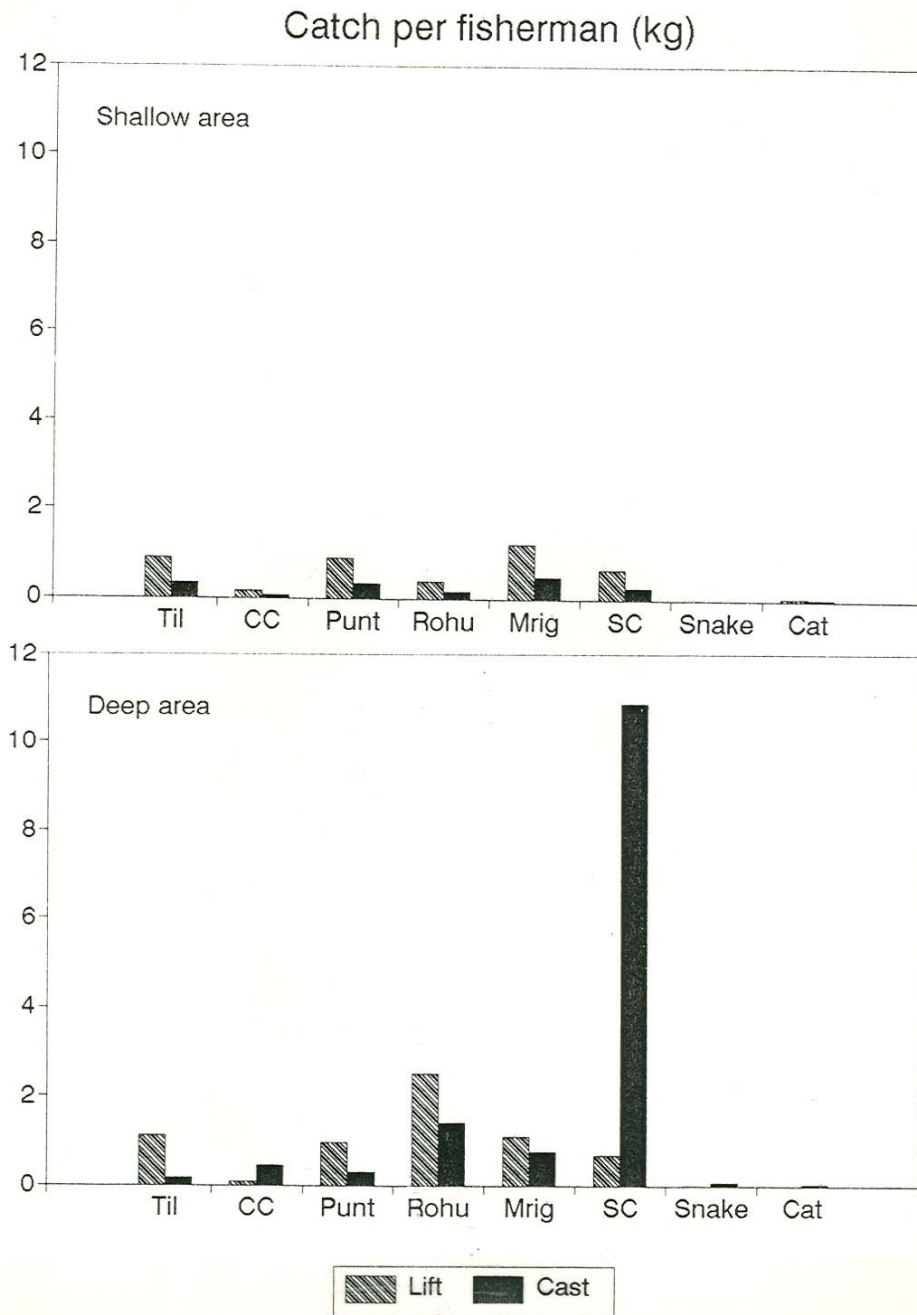

**Figure 13. Average catch per fisherman in the deep and the shallow area of the small reservoir in Poorsi Sumran.** Hatched bars denote lift net, solid bars denote cast net catches. Species caught are tilapia (Til), common carp, (CC), Thai silver barb (Punt), rohu (Rohu), mrigal (Mrig), silver carp (SC), snakehead (Snake) and walking catfish (Cat).

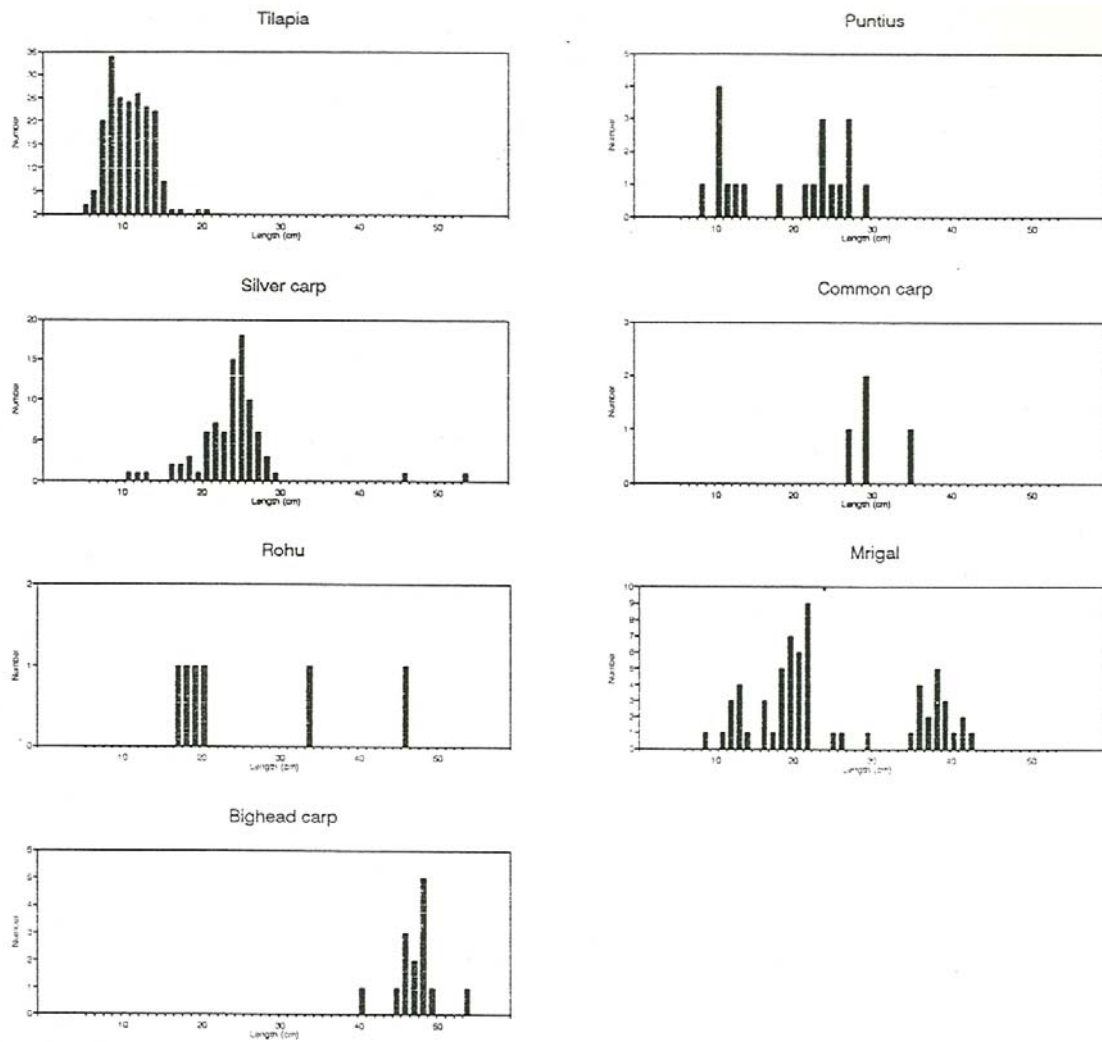

**Figure 14. Catch length frequency distributions of the stocked species in Hong Lak Tuk small reservoir**

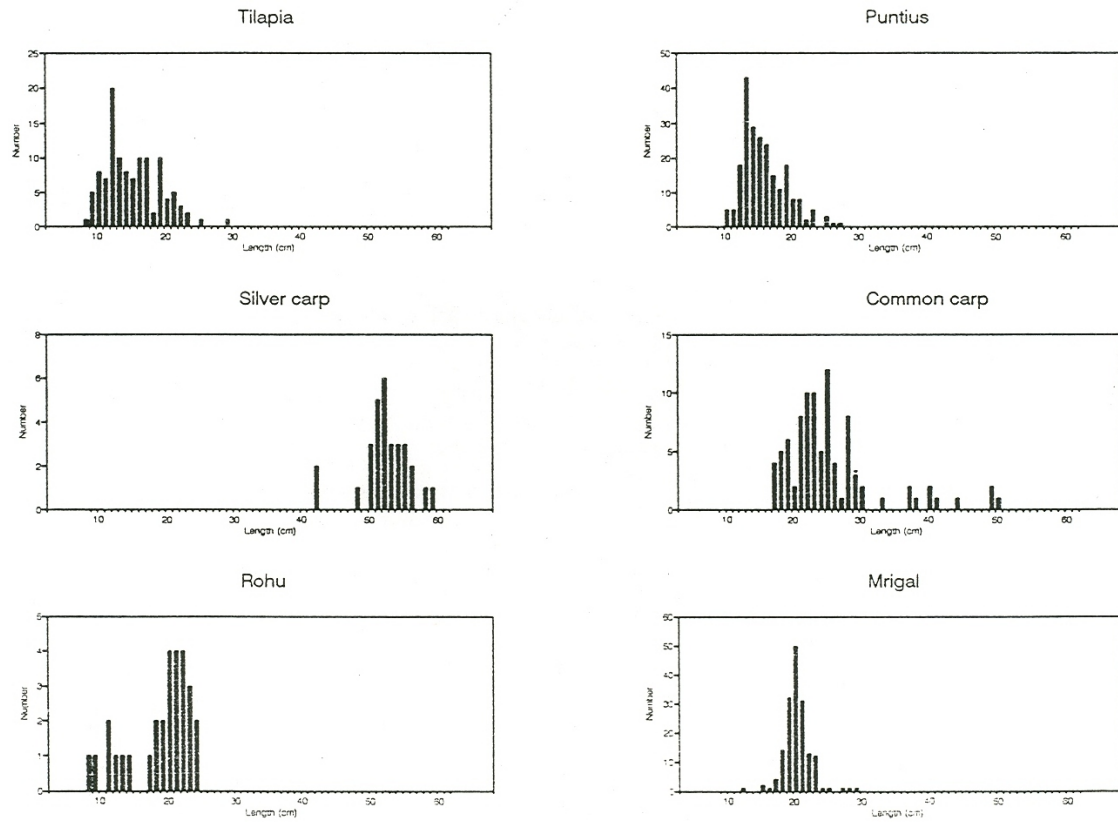

**Figure 15. Catch length Frequency distributions of the stocked species in Poo Sri Sumran small reservoir.**

#### 4.1.5 Evaluation of management options

A complete, quantitative evaluation of stocking and harvesting options using the population model is not possible at present. Stocking and catch data are available for only one growth period, so that the growth response to changes in density can not be estimated. Nevertheless, the modelling results presented in Section 3 provide qualitative criteria for the evaluation of stocking and harvesting policies in the absence of reliable parameter estimates.

The majority of communal reservoirs in NE Thailand are perennial, and the catch sampling results show that they indeed harbour fish populations consisting of several age groups. Despite the perennial nature of the water bodies, the culture-based fisheries are essentially managed as seasonal fisheries, with one stocking and one harvesting event per year. Modelling results (see Section 3) indicate that this form of management results in a loss of production as compared to more frequent stocking and harvesting. Stocking several times a year and frequent or continuous harvesting would also increase the food security benefit from the pond, and avoid the flooding of the local market that may accompany annual fishing days. However, such management would also require more labour input, and perhaps more complex access rules to regulate frequent or continuous fishing.

A general intensification of fish production in the reservoirs using higher fertilizer and feed inputs is technically possible, and would significantly increase production and profit. This is demonstrated in some privately owned water bodies that are physically similar to the communal reservoirs. At present, such intensification in communal reservoirs is prevented by use conflicts, and a reluctance of community members to provide the necessary inputs. The latter problem is probably attributable to two factors: lack of labour, and non-equitable distribution of benefits under the present management system.

There is clearly scope to increase production, but the necessary changes in management would involve complex socio-economic as well as technical issues. To address these issues, participatory rural appraisals are being carried out at present, which will be followed by a quantitative economic analysis of management options. Recommendations will be made on the basis of these studies.

The assessment of species combination and stocking density is a more restricted problem. Modelling results indicate that the highest production is achieved if fish are produced at the minimum marketable size. The optimal stocking density in a seasonal fishery is thus determined by the minimum marketable size. A crude estimate of optimal stocking density can be obtained by assuming that the harvested biomass of each species equals its production potential. Potential production can then be divided by target individual weight growth, to obtain target densities at harvesting. Optimal stocking density equals density at harvesting divided by the survival rate. This approach is commonly used to determine stocking densities in pond culture. It is based on the assumption that total production is independent of stocking density, hence it amounts to moving along a line of slope -1 in a logarithmic plot of weight against density, e.g. Fig. 1. Because in reality production is not independent of stocking density, the method gives biased estimates of optimal density: if the present density is too low, the predicted optimal density will still be a little too low, and if the present density is too high, the predicted density will be too high. In both cases, however, the predicted optimal densities will represent considerable improvements over the present situation.

In Fig. 16, the actual stocking densities in the last growth period are shown, together with optimal densities estimated as described above. The overall stocking density in Poo Sri Sumran was much higher than in Hong Lak Tuk (Fig. 16 A). Chinese carp, which account for more than 50% of the catch in both reservoirs are stocked at relatively low densities (below 10% of the total stocking density). The predicted optimal densities for the production of 0.15 kg fish are very similar for both reservoirs (Fig. 16 B). Chinese carp are to be stocked at high densities of 6000-8000 per hectare, while optimal densities for the other species vary between 1000 and 2000 per hectare. Stocking of tilapia may not be necessary at all, given that the species has established a breeding population.

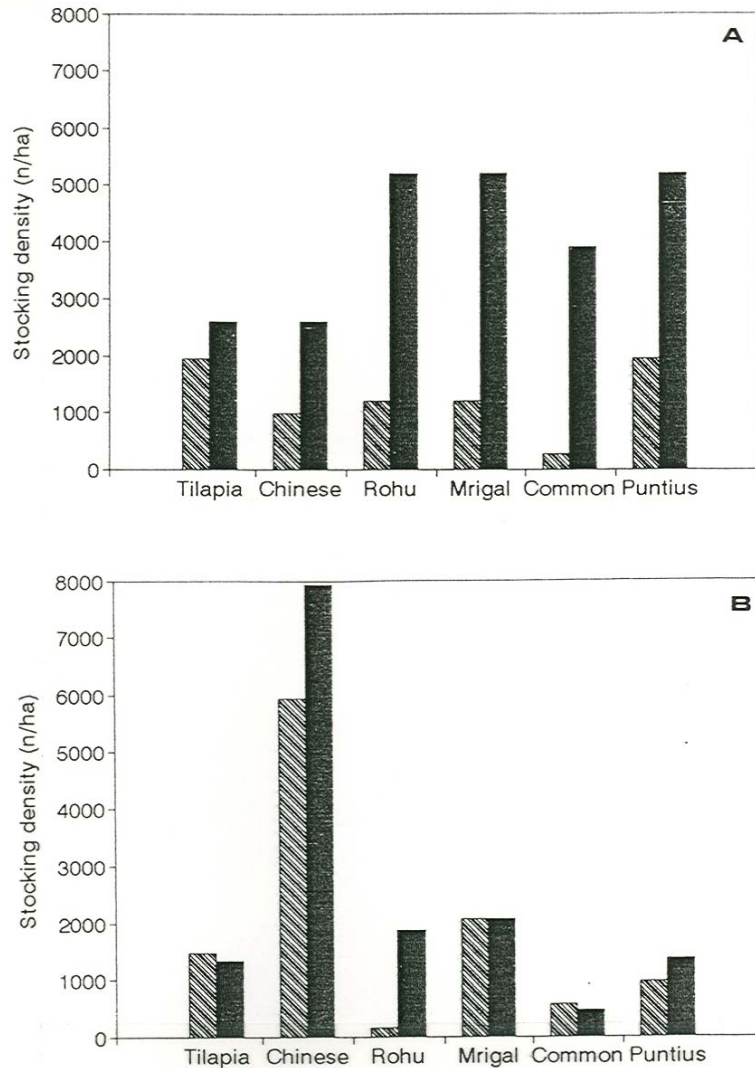

**Figure 16. Stocking density per species in Hong Lak Tuk (hatched bar) and Poo Sri Sumran (solid bar) reservoirs.** (A) Stocking densities during the growth period 1993-1994. (B) Stocking densities recommended on the basis of observed species biomass and a target size at harvesting of 0.15 kg.

The relative stocking densities of different species reflect their relative yields during the last production period. In terms of feeding habits, the relative yields and optimal densities for both ponds are very similar, comprising 68% plankton feeders, 23% benthic feeders, and 9% macrophyte feeders. The yield of plankton feeders in the last production period was apparently limited more by stocking density than by food supply, so that the adoption of the recommended stocking densities is likely to further increase the dominance of plankton feeders in the catch.

At present, stocking densities of different species are determined by the seed production of DOF and private hatcheries. The resulting combination of stocking densities is unsuitable to make full use of the production potential of extensively managed ponds. The herbivorous silver barb for example are easy to produce and often overstocked, while the planktivorous Chinese (silver and bighead) carp are more difficult to produce and are usually understocked.

The recommended total stocking density for Hong Lak Tuk is 11,170 fish per hectare, a 48% increase over the 7550 fish/ha stocked in the last period. The seed cost would increase by 77% to 1730 B/ha. In Poo Sri Sumran, stocking densities should be reduced by 40% to 15,030 fish/ha, which would reduce the seed costs by 24%, to 2480 B/ha. Both changes are expected to increase production, but the magnitude of the increase is difficult to predict.

#### **4.1.6 Research needs**

Given that small reservoirs serve multiple purposes, and that the fish harvest from the reservoirs on average contributes only marginally to household income, the maximisation of reservoir fish production appears as too narrow a focus for research. Optimal reservoir fishery management for multiple objectives, including fish production, food security and water quality improvement, would be a more appropriate focus. This will require the combination of three approaches: (1) Participatory appraisals of different reservoirs, to obtain in-depth information on current uses, problems and options as perceived by the user community. These appraisals are also likely to generate interest in further participatory research and extension. (2) The impact of physical factors and different management regimes on fish production, environmental parameters and non-fishery uses should be studied empirically. The development of simple indicators for fish management options (for example Secchi depth and water colour scales as predictors of stocking density) would be particularly useful, while precise and data-demanding tools are unlikely to be of practical use. Continuous consultation with users is essential for the research to be successful and relevant. (3) Extension methods should be developed to communicate management options and assessment criteria to user groups. Given the diversity of small reservoirs, it is essential to extend simple assessment tools and criteria, rather than predefined technologies. Experiences from participatory research will be very valuable for the development of extension methods.

## **4.2 Medium-size reservoirs in Zhejiang Province, P.R. China**

Reservoir construction in Zhejiang Province has been carried out on a large scale since the "great leap forward" in 1958. Systematic development of reservoir fisheries started around 1960, with research on stocking regimes and fishing techniques.

Reservoir fisheries are managed and operated by reservoir authorities under the Water Conservancy Bureau, which is responsible mainly for irrigation. Reservoir authorities produce or buy the fingerlings, control the harvesting, and market the produce. At present, an increasing number of reservoir fisheries are contracted out to private companies.

The main species stocked in reservoirs are silver carp and bighead carp. Both are low value species, but these plankton feeders make optimal use of the natural production potential of oligotrophic reservoirs. Neither species reproduces naturally in the reservoirs. Hatcheries are situated near the larger reservoirs, and broodstock are obtained from the reservoir during the harvesting season. Seed fish are nursed to a large size (about 13 cm length) in net cages or protected bays of the reservoir (Fig. 17).

Reservoirs are harvested once a year in winter, when demand is highest and fish can be transported live over long distances. Harvesting is done in a highly organized way, removing 80% of the marketable stock each year. The minimum marketable size of silver and bighead carp is about 1 kg, and the average weight of fish in the catch is about 1 kg in small reservoirs, and up to 3 kg in larger reservoirs where fishing effort is lower.

The case study in Zhejiang Province does not have an active fieldwork component. Instead, the collaborating institute provided detailed, long-term records of stocking and catch data for three reservoirs.





**Figure 17. Nursing of seed fish for stocking in Dong Feng reservoir, P.R. China.** Top: Net cages in the reservoir. Bottom: Enclosed bay receiving wastewater from the pig farm in the background.

#### 4.2.1 Evaluation of stocking and harvesting in Hu Shan Reservoir

Hu Shan reservoir has a surface area of 460 ha, and its main purpose is hydroelectric power generation. The reservoir was flooded in 1974, but fish stocking only started in 1985. The water level of the reservoir fluctuates widely, but no records were available to the project.

The stocked species are silver carp and bighead carp, and detailed stocking and catch data are available for the period 1985 to 1989. The data comprise information on stocking density, average weight of seed fish, total catch by species, age distribution of the catch, and weight at age. On the basis of this information, using virtual population analysis, it was possible to estimate natural and fishing mortality rates, and to reconstruct the populations of silver and bighead carp.

The harvesting efficiency, i.e. the proportion of the population harvested in each fishing season is shown as a function of age in Fig. 18. While few one and two year old fish are harvested, harvesting efficiency for three year old and older fish is as high as 80%. The annual fishing campaign, which takes place during about two weeks, is thus both efficient and highly size selective.

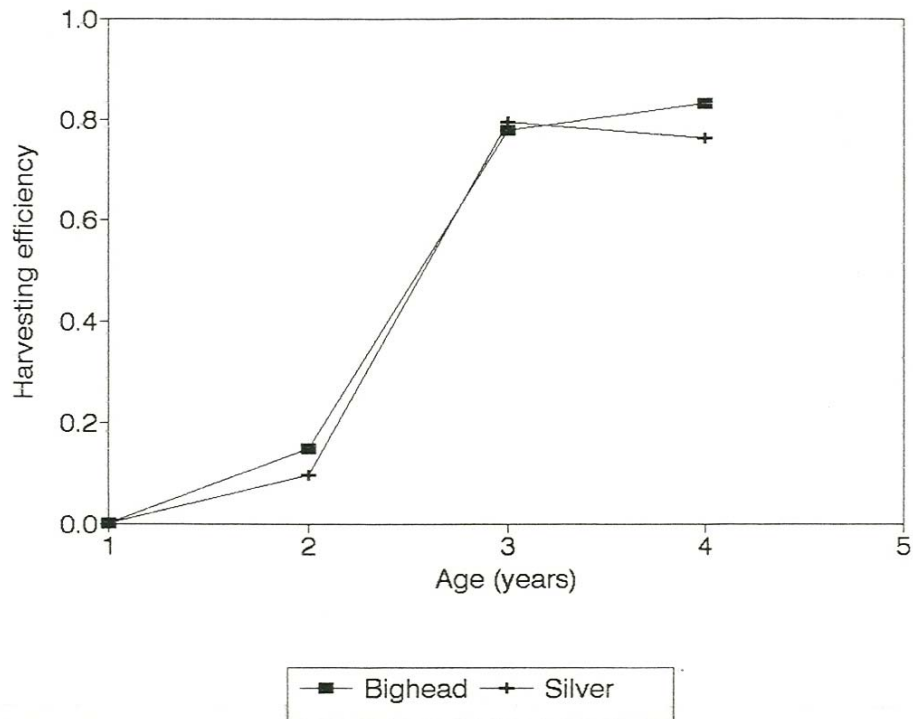

**Figure 18. Harvesting efficiency (proportion of population harvested per fishing season) for silver carp and bighead carp, Hu Shan reservoir, P.R. China.**

The stocking density, yield and reconstructed population biomass for both species are shown in Fig. 19 A and B. Stocking density, yield and biomass are generally lower for silver carp than for bighead carp. The development of weight at age during the period is shown in Fig. 19 C and D, for age groups 1, 2, and 3. In both species, weight at age increases from 1986 to 1988, despite a peak in silver carp biomass in 1987, and a continuous increase in bighead carp biomass. The change in weight at age during the period is apparently related to environmental factors rather than to population biomass. Hence it is not possible to estimate parameters of the density-dependent growth function from this data set.

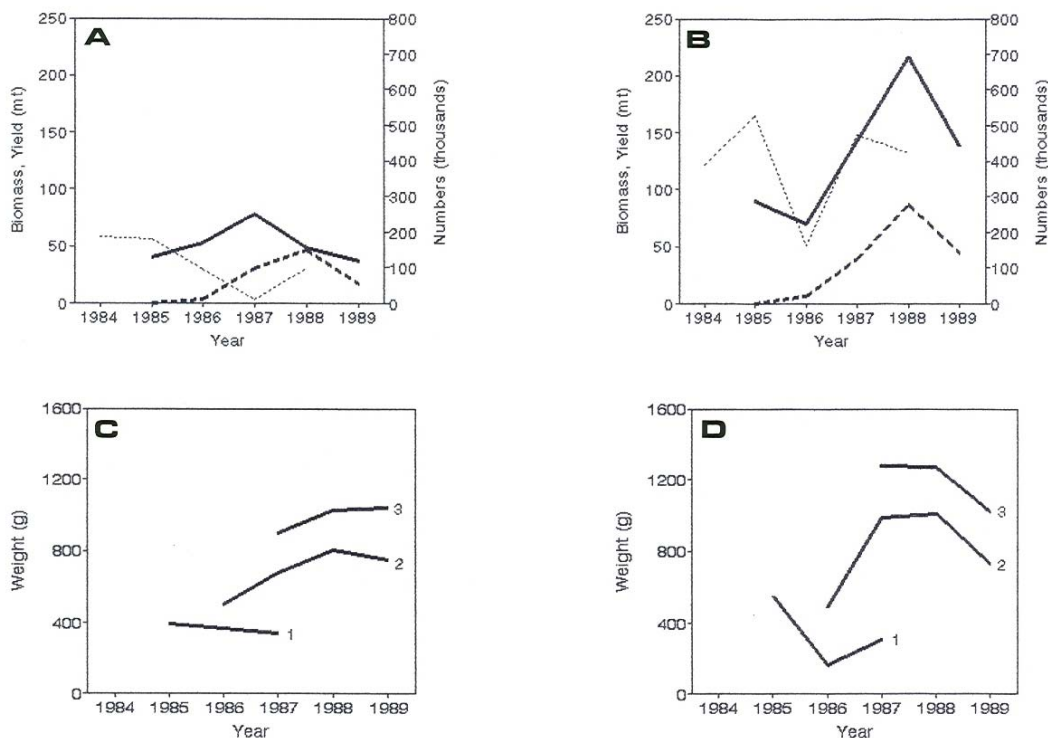

**Figure 19. Culture-based fishery for silver carp and bighead carp in Hu Shan reservoir, P.R. China.** Stocking density (dotted line), population biomass (solid line) and yield (dashed line) of silver carp (A) and bighead carp (B). Development of weight at age over time for silver carp (C) and bighead carp (D). Age is indicated in the graphs.

A quantitative prediction of optimal stocking density requires information on the growth response to changes in population biomass. In the case of Hu Shan reservoir, this information is inconsistent. However, yield per recruit analysis can be used to indicate whether the fishery is overfished (understocked) or overstocked (underfished). Yield per recruit as a function of relative fishing mortality (current  $F=1$ ) is shown in Fig. 20. Yield increases with decreasing fishing mortality, to reach a peak at 50% of the current mortality. The fishery is overfished, and yield could be increased by either a decrease in fishing mortality (harvesting efficiency), or by an increase in stocking density.

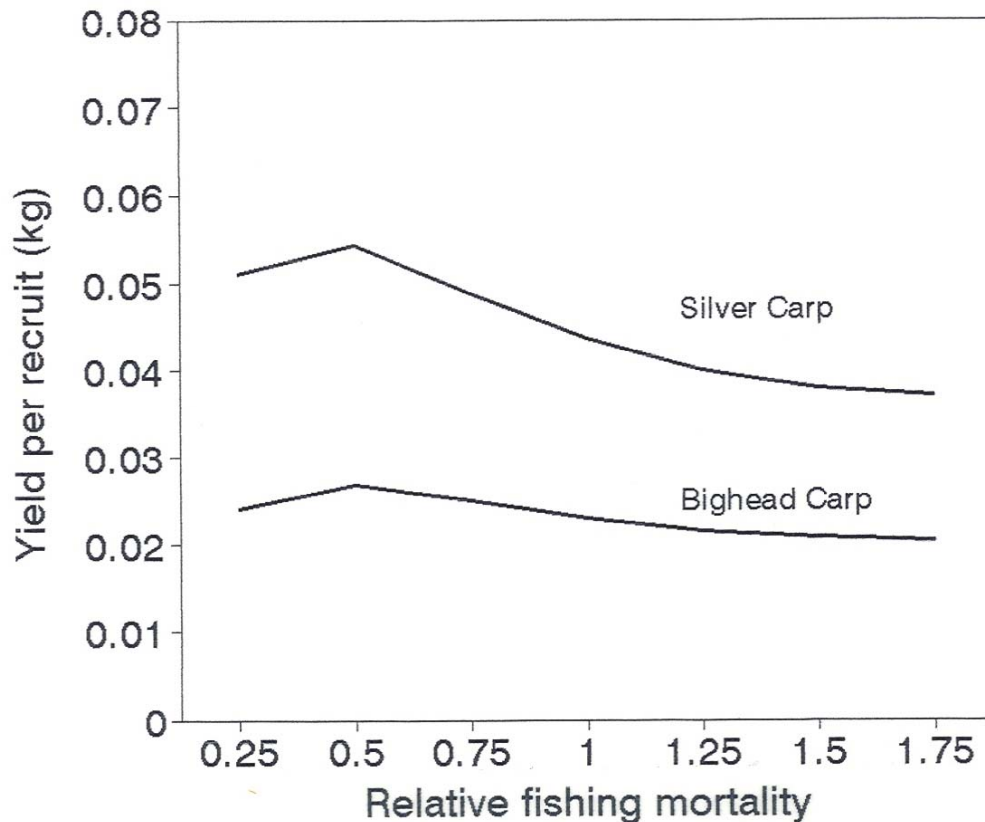

**Figure 20. Yield per recruit of silver carp and bighead carp in Hu Shan reservoir as a function of relative fishing mortality in 1984-89 equals 1**

#### 4.2.2 Research needs

The Hu Shan Reservoir case study exemplifies the need for further development of quantitative assessment tools for fisheries in perennial reservoirs. Adaptive management policies should be designed to take into account environmental factors, either as explanatory variables or as sources of stochastic variation. In larger reservoirs where big fish are produced the dynamics of the resource are slow and it may take some years before density-dependent parameters can be estimated and optimal stocking and harvesting regimes determined. The careful design of adaptive management policies is crucial in this situation if unnecessary losses of production are to be avoided.

The development of comprehensive bio-economic models for culture-based fisheries is needed in order to evaluate the economic costs and benefits of management options and adaptive policies. Simple potential yield models for culture-based fisheries should be developed, so that the potential of a fishery can be assessed prior to the necessary investment in hatcheries and fishing craft and gear.



### 4.3 Irrigation reservoirs in Karnataka State, India

The 54 irrigation reservoirs in Karnataka, India, on average cover about 4000 ha, and are 10 to 40 m deep. The reservoirs do not strictly fall into the "small" category, but the culture-based component of their fisheries is significant, and is likely increase in the future. Stocking of reservoirs in the state started around 1980 and is carried out by the Karnataka Department of Fisheries.

The reservoirs are perennial, and are fished all year round, with a peak during the monsoon when stocked fish aggregate near the shore. Stocked species are Indian major carp (catla *C. catla*, mrigal *C. mrigala* and rohu *L. rohita*), and common carp (*C. carpio*). Seed fish are nursed in ponds to a length of 5-7 cm.

Total annual yield from the reservoirs averages at 10 kg/ha, about 30% of which is based on stocking. Stocked species are caught at a relatively large size of 1-2 kg. Access to the fishery is formally limited through a licensing system, operated by the Fisheries Department, but the licence fee is nominal and the number of licences unrestricted.



**Figure 21. Nomadic fishermen operating on a reservoir in Karnataka.** The gill net is used for catching stocked carp and some large wild fish. The typical fishing craft, a coracle, can be seen in the background.

Fishing is not a traditional activity in inland Karnataka, and fishing effort in the reservoirs remains low despite attempts by the Karnataka Department of Fisheries to encourage entry into the fishery. Reservoir fisheries are operated mainly by a small and ethnically distinct group of nomadic fishermen. The main gear are gill net, drag net, cast net, and hook and line. The gear are set from coracles, small and lightweight fishing craft made of bamboo and fertilizer bags (Fig. 21).

The marketing of fish varies locally and seasonally. During the monsoon, reservoir catches are highest, and at the same time the landings of marine fish decline. Reservoir fish are bought by middlemen at the landing sites, and distributed throughout the state. Outside the monsoon, catches are lower and less attractive for middlemen. Fish are then sold at local markets by women from the fishing communities.

The study in Karnataka was limited to catch sampling from the large Vanivilas sagar Reservoir (surface area 8000 ha). Dates are still forthcoming. The data available at the moment only permit a description of the fishery, but no quantitative assessment.

#### 4.3.1 The fishery of Vanivilas sagar Reservoir

The species distribution of the catch from Vanivilas sagar is shown in Fig. 22. Stocked species contribute about 35% to the catch in weight, and possibly some 50% in value. Common carp are most prominent, followed by rohu, catla and mrigal. Common carp is known to breed in some Indian reservoirs, and it is possible that this also happens in Vanivilas sagar. Hence the catch of common carp may not be entirely attributable to regular stocking.

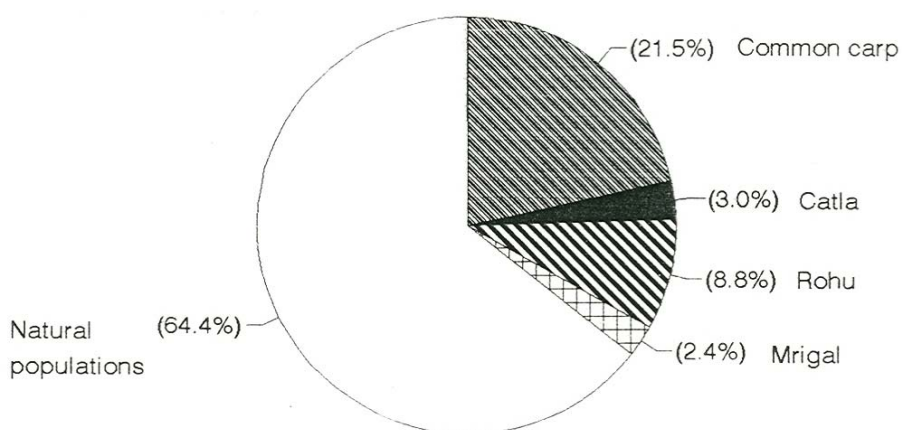
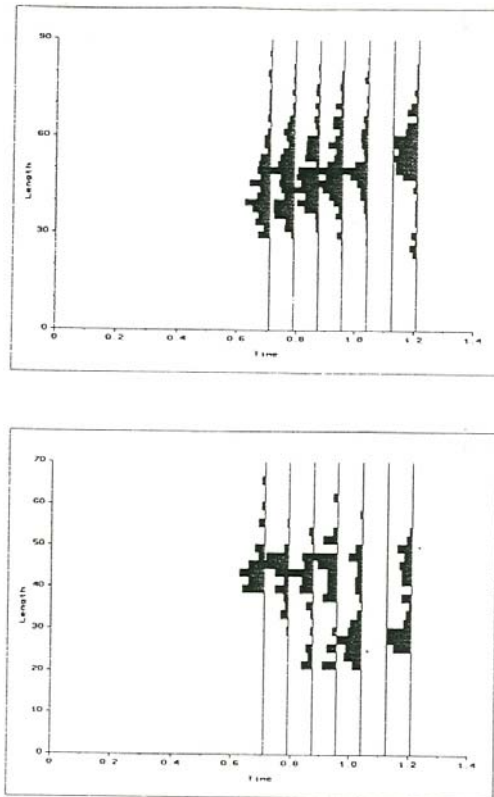

**Figure 22. Contribution of stocked species to the catch from Vanivilas sagar Reservoir, Karnataka.**

Length frequency distributions of common carp and mrigal are shown in Fig. 23. The distributions show that most fish harvested are of a relatively large size. The distributions have been obtained at the landing sites, and comprise fish caught by a wide variety of gear types and different meshsizes. Most of the gear used are selective, which makes it difficult to interpret the distributions in terms of fish growth. Although some modes are apparent in the distributions, their validity for growth studies is impossible to ascertain.

The problem of selective gear is difficult to overcome in catch sampling from a small scale fishery like that in Vanivilas sagar. Only one of the widely dispersed landing sites can be visited per day, and the catch is usually between 5 and 15 individuals per species. If fish caught by the most selective gear are excluded, this leaves very few fish to make up a length distribution. This suggests that extensive catch sampling may be an inefficient way of gaining information for the assessment of a reservoir fishery characterized by low yield and low effort.

Qualitatively, it is clear from the modelling results that the biological production of a culture-based fishery with low stocking density, effort and yield could be increased if fishing was intensified and stocking density increased. However, the possible magnitude of the increase is difficult to predict on the basis of the present, very limited data. Moreover, increased biological production does not necessarily increase the economic benefits from the fishery.



**Figure 23. Catch length frequency distributions of (A) common carp, and (B) mrigal from Vanivilas sagar reservoir, Karnataka.**

#### 4.3.2 Research needs

Efficient sampling techniques for the assessment of culture-based fisheries in large tropical reservoirs need to be developed. Catch data alone are difficult to interpret in fisheries dominated by gillnets and other highly selective gear. The possibility of co-operative surveys with multi-mesh gillnets, operated by local fishermen, should be explored. Such surveys are likely to be more cost effective than extensive catch sampling programmes. The marking (by fin-clipping) of certain batches of seed fish is also likely to increase the value of both catch and survey data.

The fishery for common carp is likely to be culture-enhanced rather than entirely culture-based. The role of stocking in an enhanced fishery is difficult to assess. Appropriate methodology for this task should be developed.

As mentioned in the Section on Chinese reservoirs, the slow dynamics of the resource in larger reservoirs means that data over a numbers of years are necessary to estimate density-dependent parameters even if sampling procedures are optimal. This again points to the importance of simple tools to assess the potential yield of culture-based fisheries.

The potential for intensifying fishing and stocking in the large reservoirs should be assessed. Besides a prediction of potential yield, such an assessment must address the likely effect on the market of increased supply of stocked fish of a smaller size, as well as the costs of increasing fishing effort and stocking density. The development of a comprehensive bio-economic model would be an important step towards such an economic assessment.



## 5 Conclusions and recommendations

---

Lack of assessment methodology for culture-based fisheries has been identified as a major problem in the development of fisheries in small and medium size Asian reservoirs. Development of relevant quantitative methodology has been the main aim of the project, and this has been accomplished. The population dynamics model for culture-based fisheries developed in the project has advanced the conceptual understanding of such fisheries, and enabled the development of quantitative assessment methods.

Most important are the following theoretical results:

- (1) The optimal stocking density, size at harvesting and fishing mortality are interrelated. A high stocking density calls for a high fishing intensity, and vice versa.
- (2) Overfishing is equivalent to understocking, and overstocking is equivalent to underfishing. Both states of a fishery can be diagnosed with a simple yield per recruit analysis, and rectified by an adjustment of either stocking density or fishing mortality.
- (3) While seed fish of different sizes can yield a similar level of production, large seed fish must be stocked at a higher biomass, and their production is particularly sensitive to stocking density.

The theoretical results on the dynamics of culture-based fisheries provide general guidelines for management, which are useful even in situations where data is insufficient for a quantitative assessment. Most important, the results also provide a basis for the design of adaptive management policies aimed at optimizing the stocking and harvesting regime by means of judicious management experiments.

Field studies in Northeast Thailand have shown that multiple uses of small communal reservoirs have a major impact on their utilization for fish production. Also, the distribution of benefits from the fishery impacts on the provision of inputs, and thus on the management intensity.

Studies on medium size and large reservoirs in China and India have shown that the general guidelines and quantitative methods developed in the project can indeed contribute to the assessment of particular fisheries. The studies have also identified a number of problems. Adaptive management of culture-based fisheries in larger reservoirs may take a rather long time to yield results of sufficient accuracy. Catch data from such fisheries may be labour intensive to get, and of limited value for stock assessment. There is an urgent need to explore the economics of culture-based fisheries in general terms, in order to obtain qualitative indicators and guidelines for quantitative economic assessment. Optimum stocking levels in self-reproducing populations (culture-enhanced fisheries) are difficult to assess, due to lack of conceptual understanding and quantitative assessment tools.

The size of seed fish used for stocking varies widely between the case study sites. Fisheries Department staff at all three sites perceive the size of seed fish as an important problem, and would prefer to produce larger seed if sufficient resources were available. Modelling results suggest that the production of large seed fish may not be beneficial, despite of their high survival rate. A rigorous evaluation of seed production systems is necessary to resolve this problem.

These conclusions lead to the following recommendations for further research:

- (1) A Bio-economic model for culture-based fisheries should be developed. This would provide qualitative insights and guidelines for management, as well as a tool for quantitative assessment where specific data are available.
- (2) The population and bio-economic models should be expanded to include natural recruitment, to allow the assessment of culture-enhanced fisheries.
- (3) Adaptive management policies and sampling strategies should be designed for culture fisheries in medium-size and large reservoirs.
- (4) Options for seed production in culture fisheries should be evaluated. The population model can be used to predict the numbers of seed fish required as a function of their size.
- (5) Research on small communal reservoir fisheries should broaden its focus from "fish production" to "reservoir fishery management for multiple objectives". This would require the explicit evaluation of uses and use conflicts, and of options for the intensification or extensification of fish production. Fish stocking should be evaluated not only in relation to production, but also as a means of water quality management.
- (6) Simple methods for the assessment of stocking and harvesting regimes in small reservoirs need to be developed and extended to the user communities. This is best achieved in a participatory research project.
- (7) Tools for the appraisal of culture fisheries development plans are required. These would include simple potential yield models, and guidelines for socio-economic appraisal.

The qualitative insights gained from modelling, and the adaptive approach to management have a good potential to improve yields from many culture-based fisheries. These results should be disseminated widely. The fisheries departments concerned should be encouraged to divert some resources from seed production to fisheries monitoring and assessment. Collaborative, adaptive research projects should be developed with key departments or institutions.